

\*unidade de medida: mm.

# Dimensional de Pontas

## Endodontia

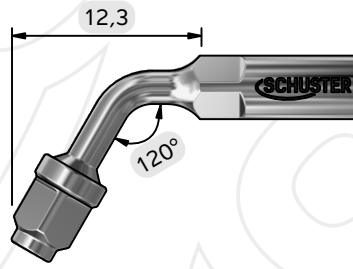
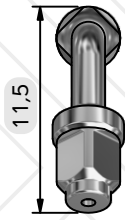

10-50%  
MÉDIA/ALTA

E1-S

COD. 100843

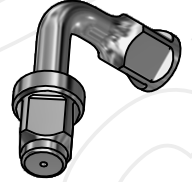
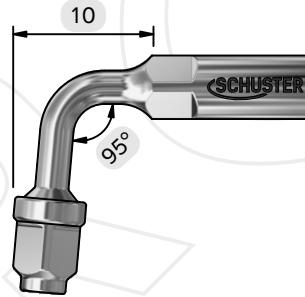
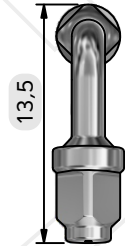

10-50%  
MÉDIA/ALTA

E2-S

COD. 101251

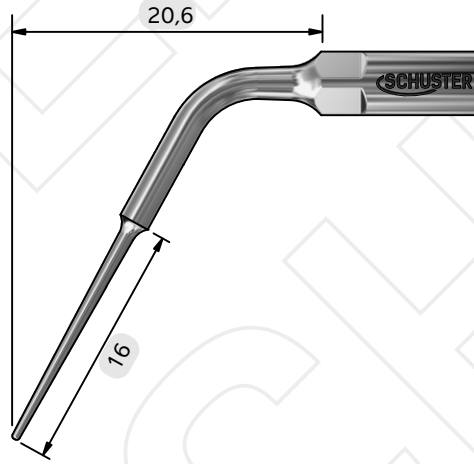
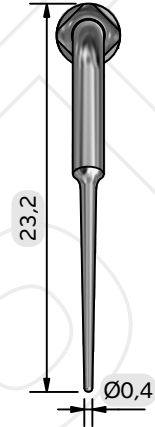

10-60%  
MÉDIA/ALTA

E3-S

COD. 101262

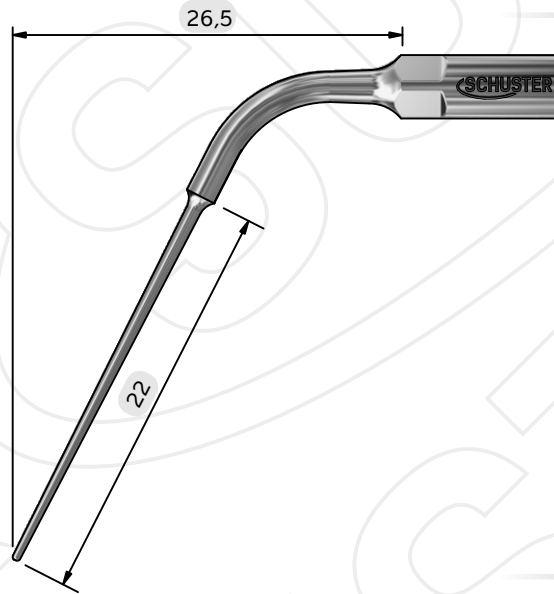
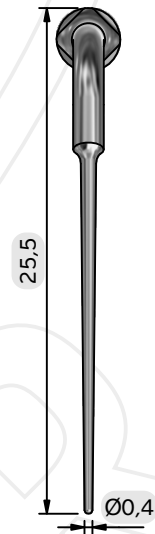

50-60%  
MÉDIA/ALTA

E4-S

COD. 101263

## Periodontia

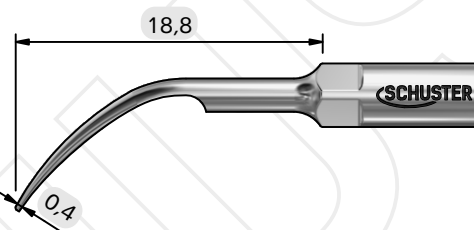
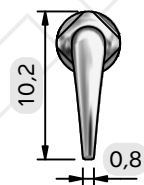

70%  
MÉDIA/ALTA

T1-S

COD. 100701

\*unidade de medida: mm.

# Dimensional de Pontas

## Periodontia

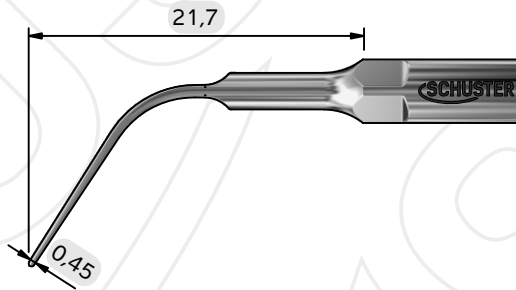
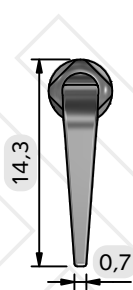

70%  
MÉDIA/ALTA

T2-S

CÓD. 100702

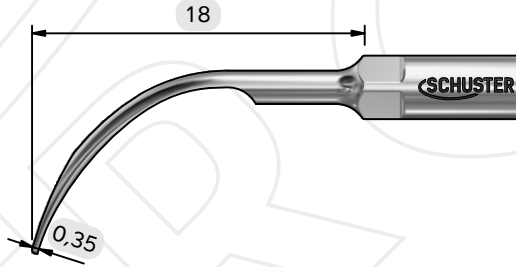
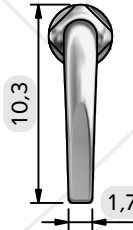

90%  
MÉDIA/ALTA

T3-S

CÓD. 100703

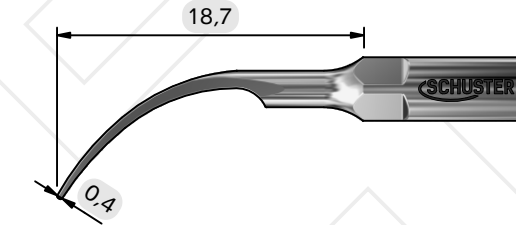
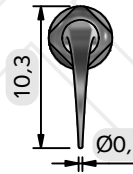

60%  
MÉDIA/ALTA

T4-S

CÓD. 101259

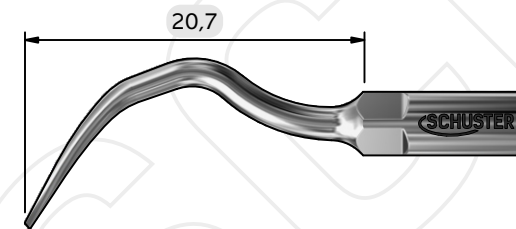
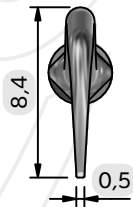

60%  
BAIXA/ALTA

G3-S

CÓD. 100408

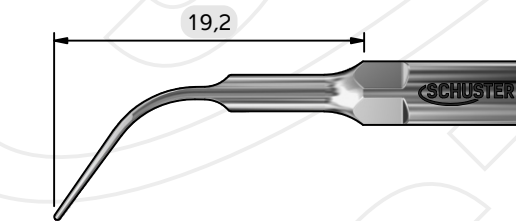
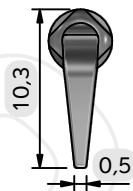

60%  
MÉDIA/ALTA

G4-S

CÓD. 101254

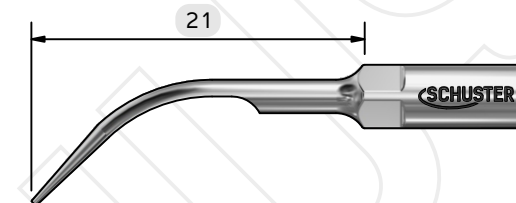
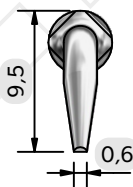

70%  
MÉDIA/ALTA

G5-S

CÓD. 101255

\*unidade de medida: mm.

# Dimensional de Pontas

## Periodontia

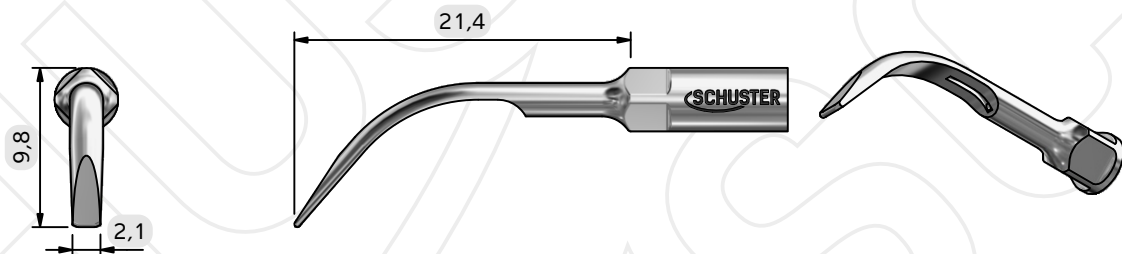

80%   
MÉDIA/ALTA  **G6-S**

COD. 101256

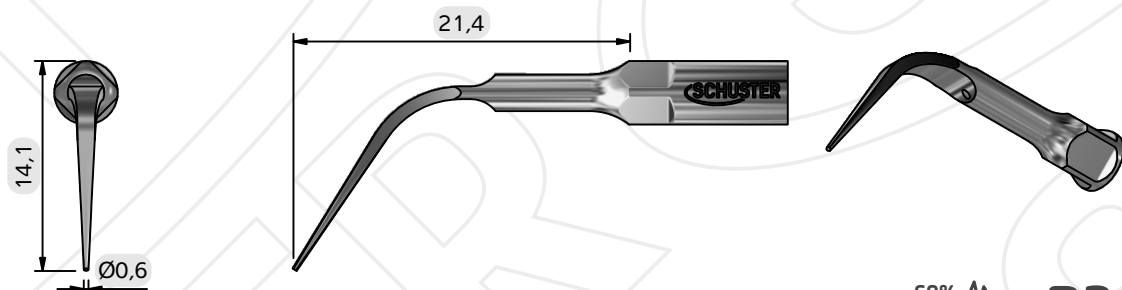

60%   
MÉDIA/ALTA  **P3-S**

COD. 101257

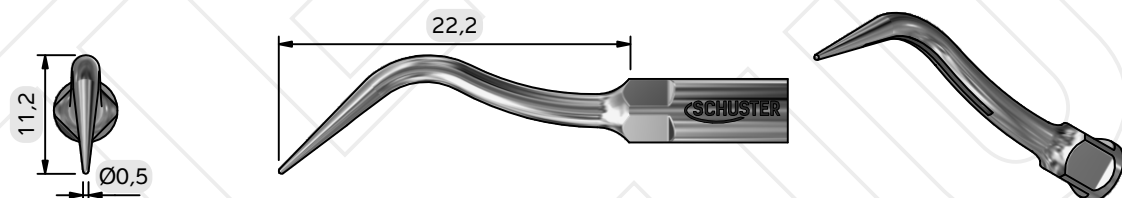

60%   
MÉDIA/ALTA  **P4-S**

COD. 101258

## Preparação Cavitária

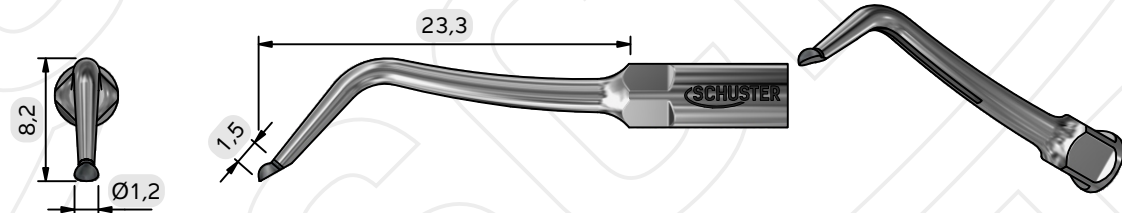

60-90%   
BAIXA/ALTA  **PC1-S**

COD. 100844

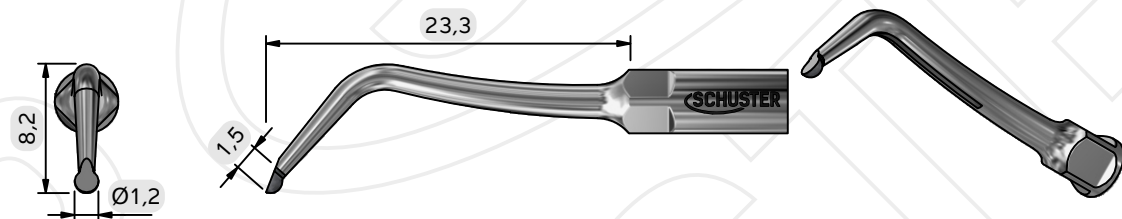

60-90%   
BAIXA/ALTA  **PC2-S**

COD. 101265

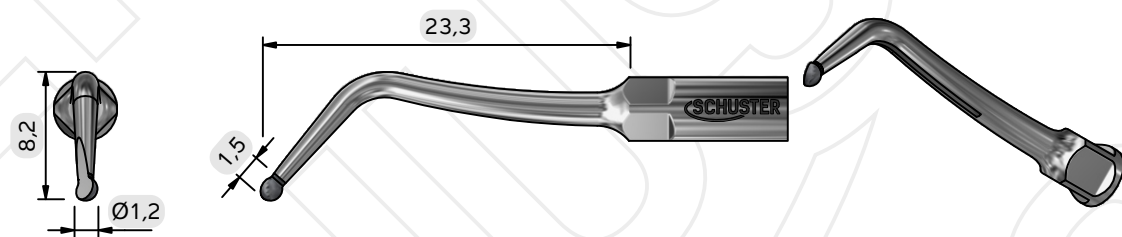

60-90%   
BAIXA/ALTA  **PC3-S**

COD. 101266

\*unidade de medida: mm.

# Dimensional de Pontas

## Preparação Cavitária

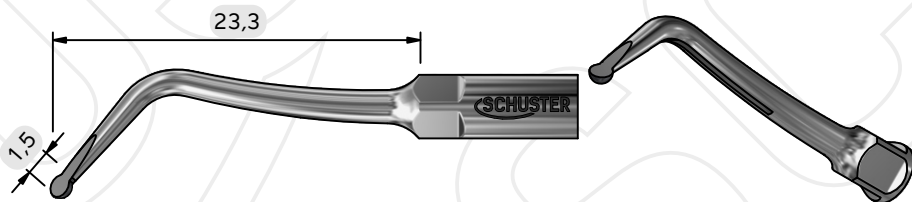
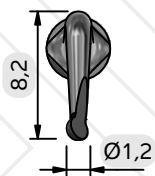

60-90%  
BAIXA/ALTA

PC4-S

CÓD. 101267

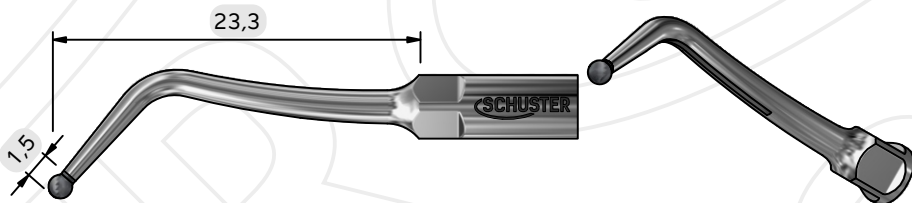
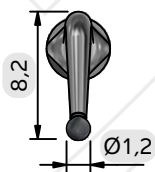

70-100%  
BAIXA/ALTA

PCU-S

CÓD. 101268

## Prótese

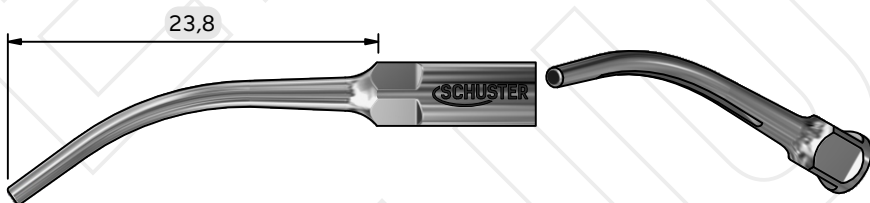
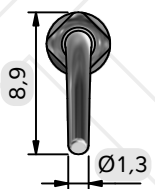

10-100%  
MÉDIA/ALTA

R1-S

CÓD. 101260

**SCHUSTER**  
ind.br